

INSTALLATION INSTRUCTIONS Modular Wall

Preparation

The right choice of tools and materials is crucial for a safe and long-lasting installation of your wall panels. When choosing your tools and materials, consider the weight of the panels and the condition of your wall. The heavier the panels and the less load-bearing the substrate, the more stable the fixings must be. An incorrect combination can cause the panels to fall and cause injuries.

Some Modular Wall products should not be screwed in. To protect the decorative surface, we recommend adhesive mounting for products with a full decorative layer.

Please note that most wall panels are not suitable for damp areas. Installation in such areas is at your own risk and requires special knowledge and materials.

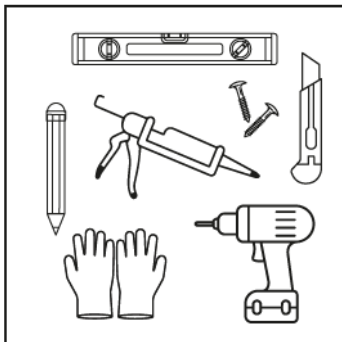

Screw:

- Cordless or manual screwdriver
- Drill, if necessary
- Screws (dowels), suitable for the wall condition
- Spirit level
- Pencil
- Gloves

Glue:

- Glue gun
- Adhesive suitable for the surface
- Spirit level
- Gloves



Please wear gloves to prevent cuts from any sharp edges or splinters.

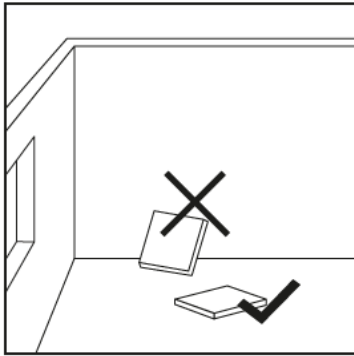

To prevent warping, never store packages and panels upright; instead, lay them flat on a level surface. Protect the panels from moisture. Expansion and contraction occur under changing humidity conditions. Moisture promotes mold growth.

The substrate must be clean and dry. Before installation, completely remove old coverings from the subfloor, if they affect the evenness or hinder the mounting.

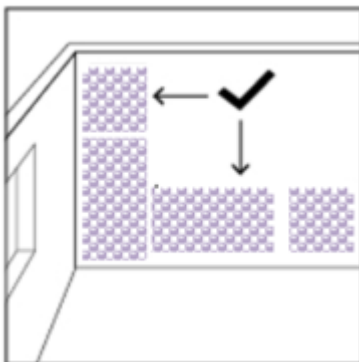

The panels can be mounted vertically or horizontally as desired.

If you cut the panels to size, use a cutter knife. We recommend that you tape the cut on the veneer with masking tape to prevent fraying.

Wall installation

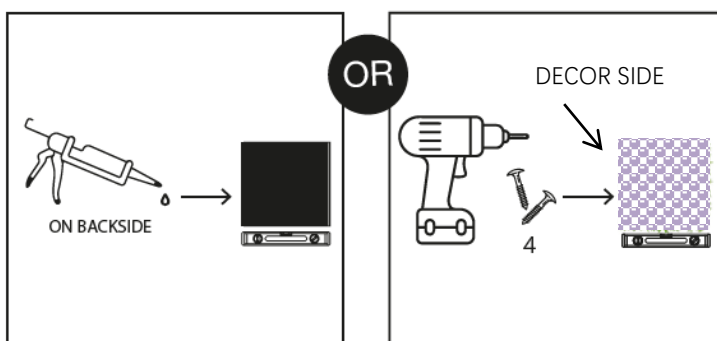

The wall panels can either be screwed or glued to the wall.

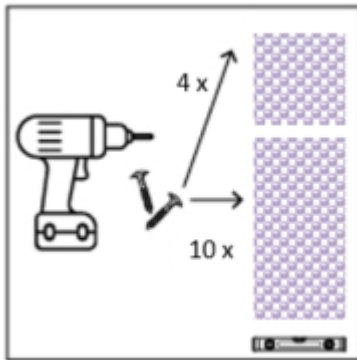

Screw:

For mounting, you will need 4-10 screws per panel (4 for the small size and 10 for the big size), which need to be evenly spaced and colour-matched to the product.

Screw through the felt. Mark the holes on the panel beforehand.

Some Modular Wall products should not be screwed in. To protect the decorative surface, we recommend adhesive installation for products with a full decorative layer.

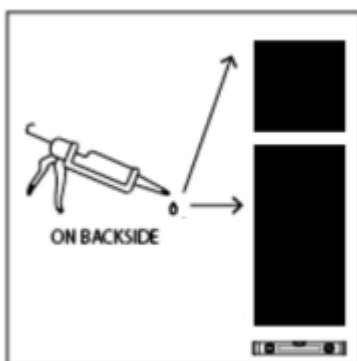

Glue:

For gluing the wall panels, we recommend a solvent-free assembly adhesive. However, the selection of the appropriate adhesive always depends on the substrate.

The adhesive is applied in spots or in serpentine lines on the back.

Align the panels with the spirit level and press on.

Multiple designs and combinations with other formats possible, for example:

JANGAL modular wall products can be combined with a wide range of other panels.

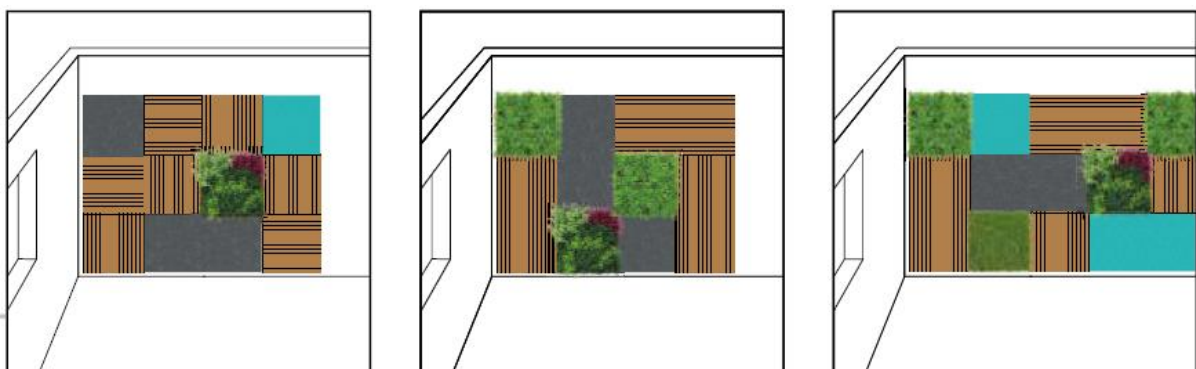

Please pay attention to the detailed instructions and safety information available at <https://jungal.eu/Downloads/> before starting the installation.

If you have any further questions about the installation of the wall panel, we will be happy to help you. Simply send us your enquiry by e-mail or give us a call.